

RANGE
Diesel platforms



Handling your world

Founded over 60 years ago by the Braud family, the Manitou Group now operates worldwide. A world-leader in all-terrain material handling, the Group designs, manufactures, distributes and services equipment for construction, agriculture and industries.

The Group's product ranges include: all-terrain fixed, rotating and heavy-load telehandlers; all-terrain, semi-industrial and industrial masted forklift trucks; wheel or track skid-steer loaders; access platforms; truck-mounted forklifts; warehousing equipment; and attachments.

Through its iconic brands, Manitou, Gehl and Mustang, and its worldwide network of 1,400 dealers, the Group offers the best solutions to create optimum value for its customers.

Headquartered in France, the Group registered a revenue in 2016 of 1,3 billion euros in 140 countries and employs 3,700 people, all strongly focused on customer satisfaction.

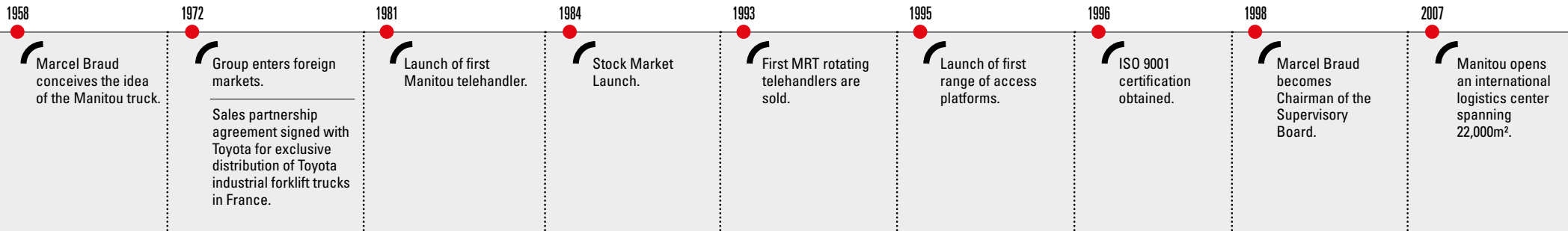

3 brands
distributed by 1,500
dealers in 140 countries

MANITOU | **GEHL** | **MUSTANG**

- 21 subsidiaries
- 11 production facilities
- 3,700 employees worldwide
- 77% of revenue comes from foreign markets
- Revenue of 1,3 billion euros in 2016

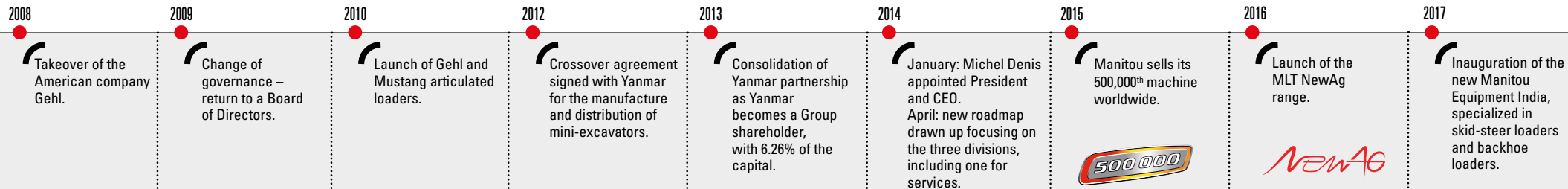

An aerial platform is shown from a high-angle perspective on a construction site. The platform is red and black, with its telescopic boom extended towards the right. The ground is a mix of dirt and gravel, with some wooden planks and rebar visible. A red laser line is projected across the ground. The platform has large, treaded tires and a control cab with a seat.

Diesel platforms Take a seat!

Discover a wide range of articulated and telescopic aerial platforms, each of which responds fully to the concerns of your profession, whether you are a renter or an operator.



CONTENTS
Diesel platforms

MAN'GO 12 aerial work platform	6
Articulated platforms	10
Telescopic platforms	14
Scissor lift platforms	18
Technical specifications	24
Standard and optional equipment	30
Taylor made solutions	33
Manitou services	34
REDUCE Fuel eco-program	38

Basket

The double handrails, fitted in the corners, protect operators' hands and enable them to make use of the whole surface of the basket. The galvanized floor can be changed independently of the basket.



Turret

The turret is rotated (350°) by means of a hydraulic motor, its speed varying according to how far the telescopic boom is extended.

Chassis:

The engine, located in the rear of the chassis, gives a lower center of gravity and makes the machine lighter. With a width of 1,800mm, the MAN'GO 12 is one of the most compact machines in its category.

Outreach

6.7m

11.9m

Working height

Basket capacity

230kg

2 operators

Structure

The special feature of the MAN'GO 12 is that it has a single lift ram. Just one lever is needed for rapid combined lifting of the arms.

Transmission

Each of the four drive wheels is powered by a hydraulic motor. Flow dividers direct the oil individually where needed. A "rough terrain" feature can be activated to improve driving conditions.

MANGO 12

Designed and tailored for rental purposes

Improved visibility

The narrow width of the turret gives the operator an excellent view of the steering wheels and allows the platform to be moved safely.



Compact and lightweight

Width 1,800mm - weight 4,150kg.

Maneuvering in tight spaces is facilitated and ground disturbance is reduced. Significant savings in terms of transport for rental companies can be made as the Mango is a smaller lighter machine than its competitors. Four hooks on the turret facilitate sling loading/lifting, four chains are all that are required for lifting, without spreader or additional equipment.



Easy to use

The ergonomic driving environment, which is standard with the rest of the diesel range, helps ensure rapid mastery of the machine.

The lifting of the structure is unparalleled in its simplicity and speed. To increase productivity even more, many movements can be combined.



MANGO12

Structural works, finishings
and fittings, cleaning,
sanding, pruning, cities,
airports, events operations

Ease of maintenance

At the end of the rental period, the inspection points must be easily accessible and identifiable at first glance. The MANGO 12 has rapid access panels to the main components (battery, gauges, fuses, filters, etc.) No tools are required to gain access. It saves time and money.

As a standard feature of the range, the base controls are simple and intuitive. It makes it possible to carry out a rapid diagnosis of the machine and test a large number of movements to detect any source of anomaly. This system also allows certain options to be enabled or disabled depending on the machine's applications.



Basket

For difficult environments and tough jobs, our standard baskets are fully galvanized. The baskets offer better resistance to extreme conditions and help to improve TCO.

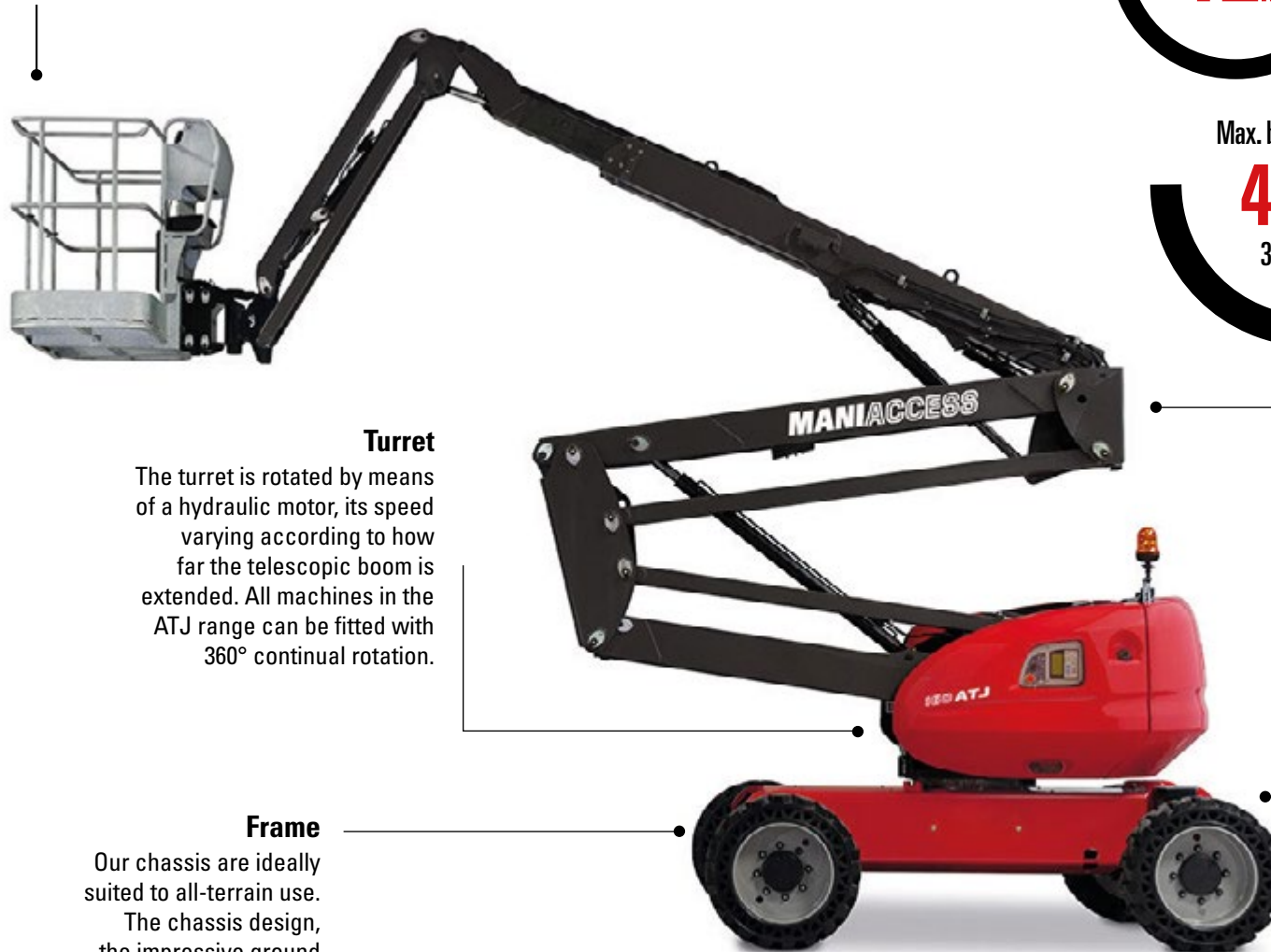

Turret

The turret is rotated by means of a hydraulic motor, its speed varying according to how far the telescopic boom is extended. All machines in the ATJ range can be fitted with 360° continual rotation.

Frame

Our chassis are ideally suited to all-terrain use. The chassis design, the impressive ground clearance and the active oscillating axle ensure excellent performance on uneven surfaces.

Max. outreach

12m

20m

Working height max.

Max. basket capacity

400kg

3 operators

Structure

Our structures have always been recognized for their rugged design and long-term durability. Whichever product you choose, the articulation heights and working outreach have become benchmarks in their category.

Transmission

Right from the outset, Manitou has fitted its all-terrain platforms with transmission decks. These highly reliable components are perfectly suited to the harshest of conditions and offer superior performance compared to other technologies on the market.

RANGE ATJ
Tackle any obstacle



All terrain capacity

ATJ models can operate on all types of surface, including 40% slopes:

- 4 drive wheels
- 3 steering modes (4-wheel, 2-wheel, crab steer)
- 2 reinforced transmission axles
- Unequaled ground clearance
- Slope allowed 5° (longitudinal and lateral)
- Oscillating axle (optional)



Simplicity of use

- Ergonomic control panel for basket and floor standardized across the whole range
- Spacious basket, easily accessible, with mesh floor for greater vertical visibility
- On-screen display constantly showing useful information (fuel level, hour meter, battery voltage, etc.)

Productivity and performance

- 4 simultaneous movements for rapid positioning
- Excellent work envelope with outreach ranging from 8.30 to 12m
- Load capacities that are unique in the articulated platform market 16m: 400kg / 3 operators (160 ATJ+) with no restrictions

Reduced maintenance

Integrated CAN Bus technology considerably reduces the number of wires and enables a rapid situational analysis to be obtained by displaying the faults and origins of the fault.

For the largest machines in the range, the engine is located on a swiveling bracket to improve access to the components.

The various models are fitted with a hydraulic management system for engine speed. The rotation speed varies according to the operator's requirements. You will notice the fuel consumption savings and the reduction in surrounding noise.



ATJ Range

Structural works, finishings
and fittings, cleaning,
sanding, pruning,
maintenance, ports, airports,
events operations

Enhanced safety

- Reinforced arm structure
- Double handrails to protect operators' hands
- Operator presence pedal
- Safety valves on the lifting cylinders
- Control panel in the basket and on the ground (to help an operator in difficulty)
- Load sensor and slope detector with visual and audible indicators.
- Negative braking system
- Backup electrical pump
- A simplified instruction sheet on each machine
- Travel speed differs according to the turret orientation
- Constant basket speed (patented)
- Operator protection system (SMS) (see page Safe Man System)



Basket

The TJ range includes large scale ergonomic baskets one or three access points. Thanks to the mesh floor, the vertical visibility is improved. As standard, all the basket are equipped with a tool storage space.

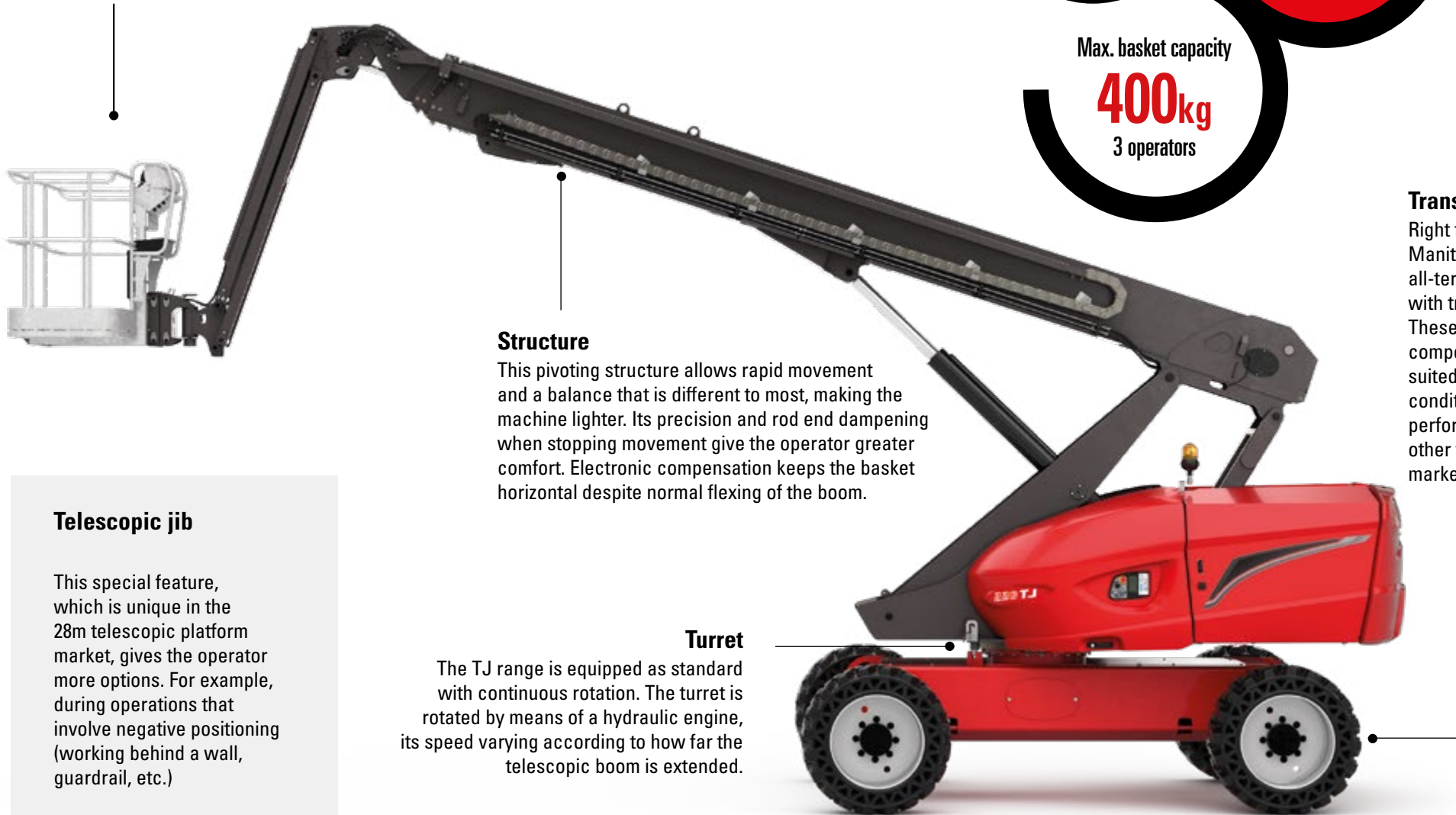

Max. outreach
21.4m

27.7m
Working height max.

Max. basket capacity
400kg
3 operators

Structure

This pivoting structure allows rapid movement and a balance that is different to most, making the machine lighter. Its precision and rod end dampening when stopping movement give the operator greater comfort. Electronic compensation keeps the basket horizontal despite normal flexing of the boom.

Transmission

Right from the outset, Manitou has fitted its all-terrain platforms with transmission decks. These highly reliable components are perfectly suited to the harshest of conditions and offer superior performance compared to other technologies on the market.

Telescopic jib

This special feature, which is unique in the 28m telescopic platform market, gives the operator more options. For example, during operations that involve negative positioning (working behind a wall, guardrail, etc.)

Turret

The TJ range is equipped as standard with continuous rotation. The turret is rotated by means of a hydraulic engine, its speed varying according to how far the telescopic boom is extended.

TJ RANGE
Reach new heights

All terrain capacity

TJ models are designed to work on uneven surfaces using standard equipment:

- 2 transmission decks
- 4 drive wheels
- Ground clearance of 430mm
- Slope allowed 4° (longitudinal and lateral)
- Oscillating front axle



Operator comfort

- Large scale basket with one or three entry points
- High capacity basket can carry three people + tools (except 220 TJ / 2 operators)
- Ergonomic control panel
- Rod end dampening during stopping of movements
- Remote control for folding (transport on a lorry)



Increased productivity

- 4 simultaneous proportional movements
- Vertical or horizontal linear movement (X/Y function) of basket (260/280TJ)
- Working outreach of more than 21m
- Telescopic jib (280 TJ) for work areas that are difficult to reach

Enhanced safety

- Switchable differential lock
- Electronic compensation of basket
- Remote control to fold the basket and the jib underneath the boom (transport, storage)
- Double handrails to protect operators' hands
- Operator presence pedal in basket
- Safety valves on the lifting cylinders
- Load detectors
- Slope detector
- Backup electrical pump

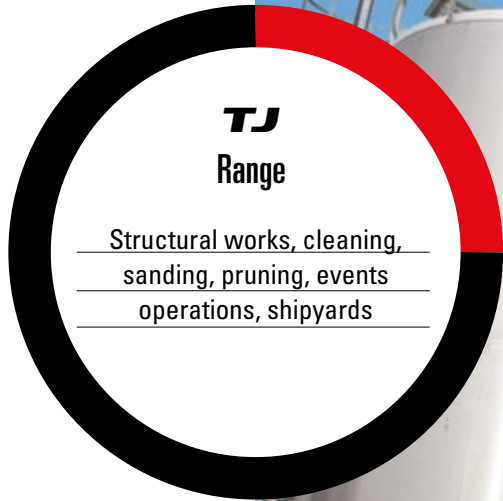

Reduced **maintenance**

Integrated CAN Bus technology enables a rapid situational analysis to be obtained by displaying the faults and origins of the faults.

The engine is mounted on a swiveling base and can be accessed rapidly.

The various models are fitted with a hydraulic management system for engine speed. The rotation speed varies according to the operator's requirements.

You will notice the fuel consumption savings and the reduction in surrounding noise.



Basket

The three models of diesel scissor platforms are designed with a unique basket size (2,790 x 1,600 mm). The non-slip aluminum floor improves operator safety. The foldable guard rails are useful when passing through low thresholds.



Extension

Each model is equipped with a basket extension of more than 1,500mm. It can be set up manually and gradually, and is useful in some situations that involve a distance between operators.



SC RANGE

Compactness and high capacity

14.2m
Max. working height

Max. basket capacity

680kg

4 operators

Transmission

The range of diesel scissor platforms is equipped with four-wheel drive transmission and an active oscillation system. This gives them good all-terrain capacities and an ability to climb slopes of up to 40%.

Stabilizers

The various models in the SC range are equipped with stabilizers with automatic leveling, ideal when working on uneven surfaces.

All terrain capacity

Whatever the state of the ground, you can move about easily thanks to the four drive wheels and the active oscillation system. When using on hilly terrain, the operator can engage the stabilizers to restore the machine to a level position.



Simplicity of use

- Compact for better maneuverability
- Wide, non-slip access steps
- Access gate
- Intuitive, adjustable operator station
- Rapid basket extension

Reduced maintenance

To facilitate maintenance and reduce downtime, Manitou scissor lift platforms have:

- Rapid access to different engine and hydraulic filters.
- An engine mounted on swiveling base
- An on-board self-diagnostic system
- Many standard components
- Easy to repair sheet metal hoods



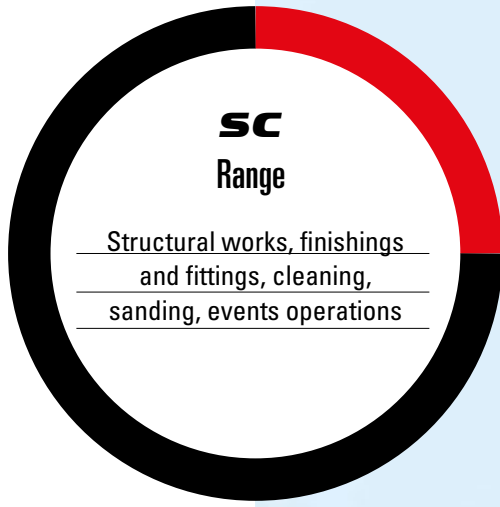

Enhanced safety

- Overload sensor with indicator
- Anti-shearing protection when lowering the platform
- Slope and lowering alarm
- Double flashing beacon

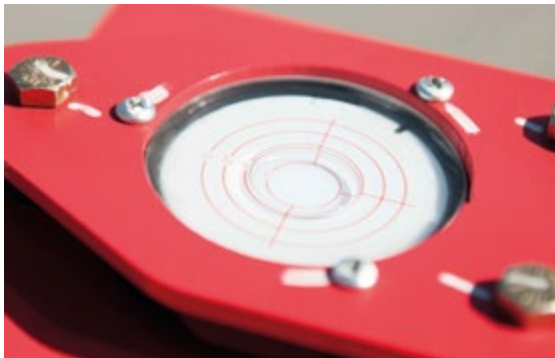



Diesel platforms 12 models to choose from

Discover our wide range of diesel aerial work platforms. On even ground or not, whether you are renting or using, Manitou platforms are the result of years of customer focus.





MAN'GO



MANGO 12



Basket capacity	kg	230
Working height	m	11.91
Height of platform	m	9.91
Working outreach	m	6.69
Overhang	m	4.8
Platform dimensions (LxWxH)	m	5.5 x 1.8 x 2.01
Transport dimensions (LxWxH)	m	4.5 x 1.8 x 2.49
Basket dimensions (LxW)	m	1.5 x 0.987
Diesel engine power	kW	Kubota - 19
Tires		Cured-on solid tyres
Weight unladen	kg	4,150

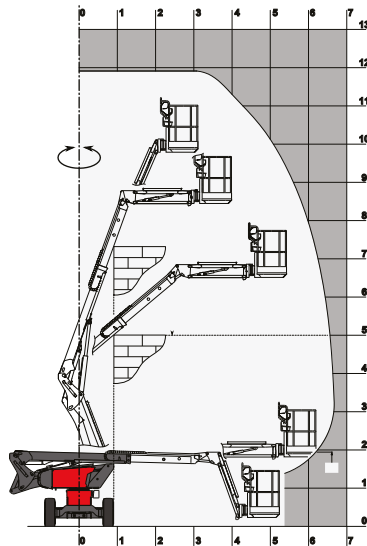

ARTICULATED



160 ATJ



Basket capacity	kg	230
Working height	m	16.01
Height of platform	m	14.01
Working outreach	m	8.3
Overhang	m	7.38
Platform dimensions (LxWxH)	m	6.53 x 2.3 x 2.37
Transport dimensions (LxWxH)	m	4.44 x 2.3 x 2.61
Basket dimensions (LxW)	m	1.8 x 0.8
Diesel engine power	kW	Kubota - 26.2
Tires		Cured-on solid tyres
Weight unladen	kg	6,160

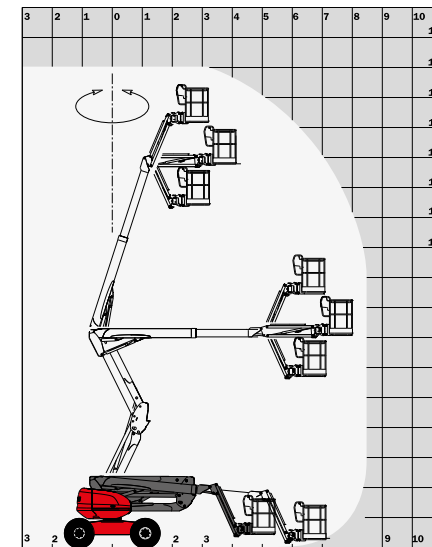

DIESEL PLATFORM RANGES



160 ATJ +



kg	400
m	16.25
m	14.25
m	8.95
m	7
m	6.93 x 2.3 x 2.37
m	4.96 x 2.3 x 2.7
m	2.3 x 0.9
kW	Kubota - 33.1
	Foam filled tyres
kg	8,100

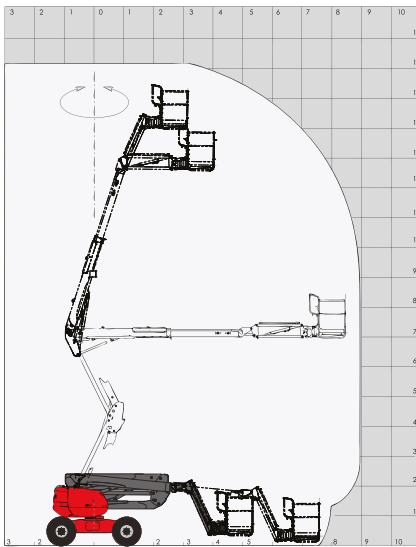

180 ATJ



kg	230
m	18.15
m	16.15
m	10.62
m	7.42
m	7.64 x 2.28 x 2.46
m	5.59 x 2.28 x 2.7
m	1.8 x 0.8
kW	Kubota - 26.2
	Foam filled tyres
kg	7,550

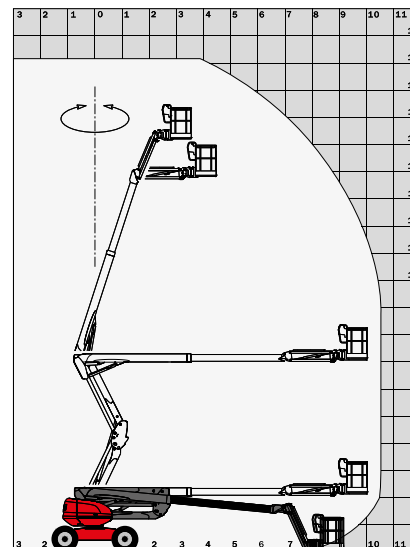

200 ATJ



kg	230
m	20
m	18
m	12
m	8
m	8.5 x 2.4 x 2.71
m	6.30 x 2.4 x 3.15
m	2.1 x 0.8
kW	Kubota - 33.1
	Cured-on solid tyres
kg	10,050

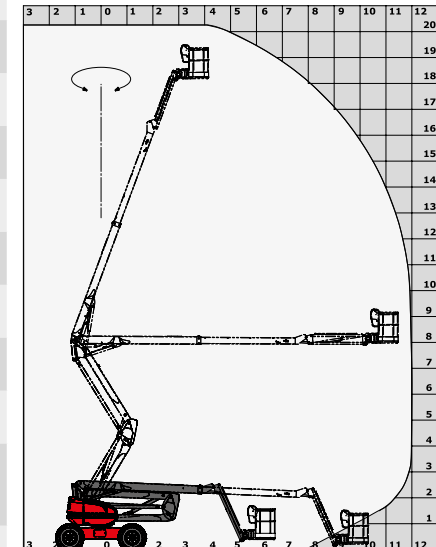

*Weight will vary depending on options and/or country standards

TELESCOPIC



220 TJ



Basket capacity	kg	230
Working height	m	21.77
Height of platform	m	19.77
Working outreach	m	17.63
Ground clearance	m	0,44
Platform dimensions (LxWxH)	m	9,80 x 2,48 x 2,47
Transport dimensions (LxWxH)	m	7,29 x 2,48 x 2,72
Basket dimensions (LxW)	m	2,1 x 0,8
Diesel engine power	kW	Kubota - 26
Tires		Cured-on solid tyre
Weight unladen	kg	11850

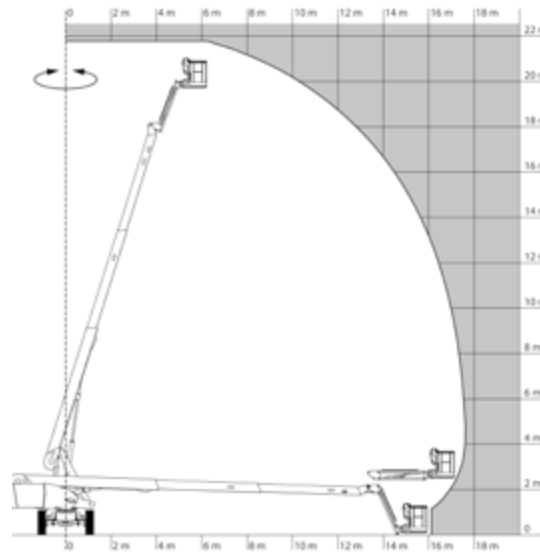

220 TJ+

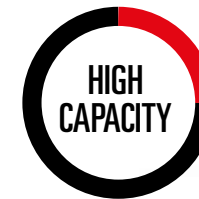

Basket capacity	kg	350
Working height	m	21.74
Height of platform	m	19.74
Working outreach	m	17.78
Ground clearance	m	0,44
Platform dimensions (LxWxH)	m	10,05 x 2,48 x 2,52
Transport dimensions (LxWxH)	m	7,35 x 2,48 x 3,03
Basket dimensions (LxW)	m	2,3 x 0,9
Diesel engine power	kW	Kubota - 26
Tires		Cured-on solid tyre
Weight unladen	kg	13600

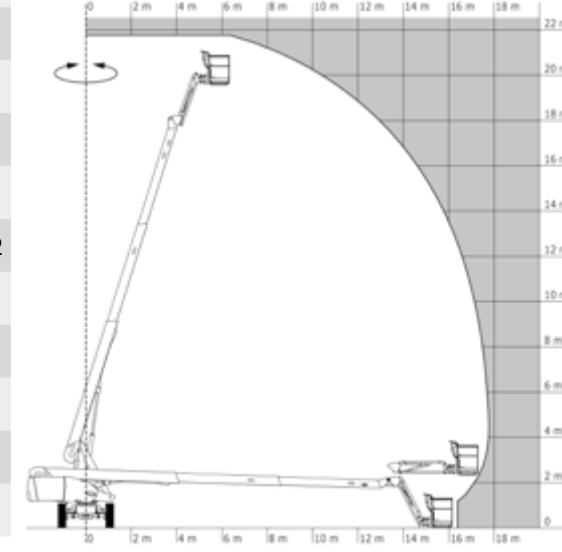

Number of people



Turret rotation



Continuous turret rotation



Drive wheel & Steering wheels



Maximum slope accessible



260 TJ



kg	400
m	25,91
m	23,91
m	19,7
m	0,43
m	10,84 x 2,43 x 2,75
m	8 x 2,43 x 2,75
m	2,3 x 0,9
kw	Kubota - 33,6
	Foam filled tyres
kg	16300

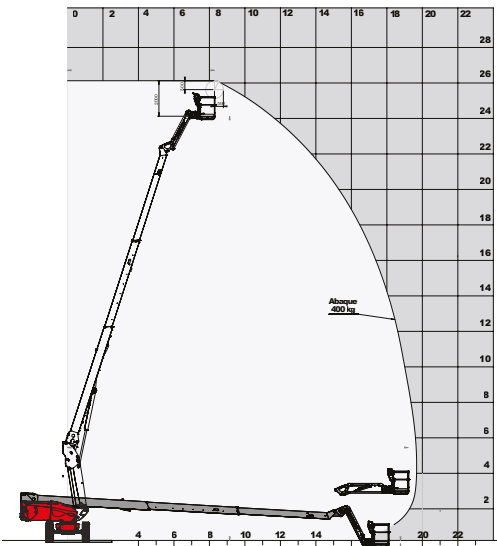

280 TJ



kg	350/240
m	27,75
m	25,75
m	21,45
m	0,43
m	11,35 x 2,43 x 2,75
m	8,04 x 2,43 x 2,75
m	2,3 x 0,9
kw	Kubota - 33,6
	Foam filled tyres
kg	16500

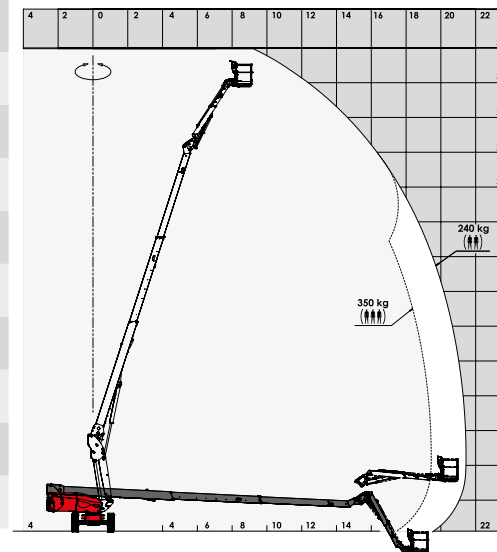

*Weight will vary depending on options and/or country standards



SCISSOR LIFT



100 SC



Basket capacity	kg	680
Working height	m	9.9
Height of platform	m	7.9
Machine dimensions (LxWxH)	m	3.76 x 1.75 x 2.59
Basket without extension (LxWxH)	m	3.12 x 1.75 x 1.92
Extension length	m	1.52
Ground clearance	m	0.24
Travel speed	km/h	5.6
Diesel engine power	kW	Kubota - 18.5
Tires		Foam filled
Weight unladen	kg	3,768

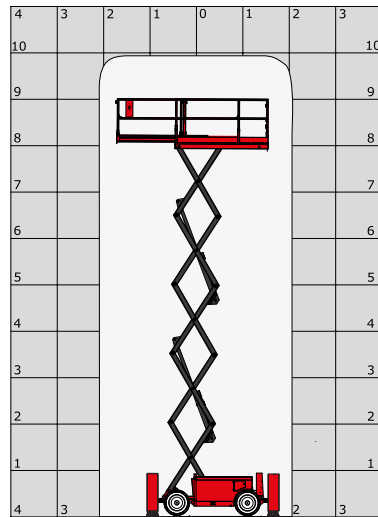

120 SC



kg	454
m	11.96
m	9.96
m	3.76 x 1.75 x 2.59
m	3.12 x 1.75 x 1.92
m	1.52
m	0.24
km/h	5.6
kW	Kubota - 18.5
	Foam filled
kg	3,949

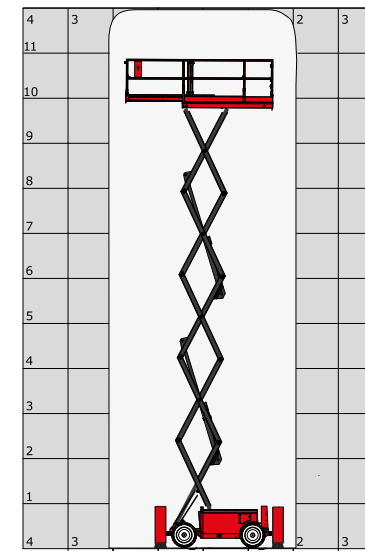

kg	363
m	14.2
m	12.2
m	3.76 x 1.75 x 2.74
m	3.12 x 1.75 x 2.08
m	1.52
m	0.24
km/h	5.6
kW	Kubota - 18.5
	Foam filled
kg	5,136



Number of people



Turret rotation



Continuous turret rotation



Drive wheel & Steering wheels



Maximum slope accessible



140 SC



MANGO

Transport dimensions (LxIhx) : 4,5 x 1,8 x 2,495 m



TJ

Transport dimensions (LxIhx) : from 7,29 x 2,48 x 2,72 m

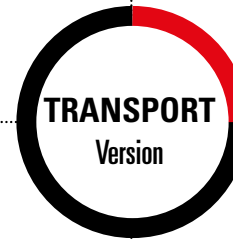
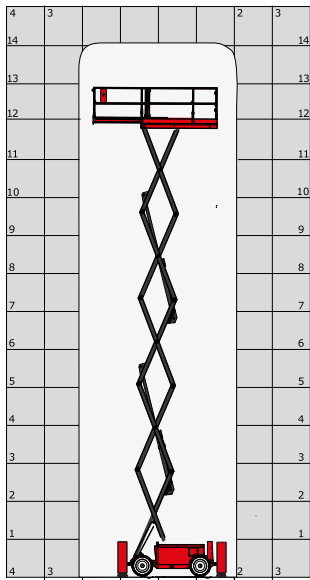

ATJ

Transport dimensions from (LxIhx) : 4,44 x 2,3 x 2,61 m



SC

Transport dimensions (LxIhx) : 3,76 x 1,75 x 2,59 m

*Weight will vary depending on options and/or country standards



	MAN'GO 12	160 ATJ	160 ATJ +	180 ATJ	200 ATJ	220 TJ	220 TJ+	260 TJ	280 TJ	100 SC	120 SC	140 SC
COMFORT AND PRODUCTIVITY												
Simultaneous movements	S X3	S X4	S X4	S X4	S X4	Sx4	Sx4	S X4	S X4			
Active oscillating front axle		0	0	0	0	S	S	S	S	S	S	S
Continuous turret rotation		0	0	0	0	S	S	S	S			
3 steering modes (4-wheel, 2-wheel, crab steer)		S	S	S	S		S	S	S			
4 drive wheels	S	S	S	S	S	S	S	S	S	S	S	S
Differential lock	S	S	S	S	S	S	S	S	S			
Electronic compensation of basket						S	S	S	S			
Front axle limited slip differential		S	S	S	S	S	S	S	S			
Fuel gauge with low level indicator	S	S	S	S	S	S	S	S	S			
3.5 kW on-board generator	0	0	0	0	0	0	0	0	0			
5 kW on-board generator		0	0	0	0	0	0	0	0			
Hour meter	S	S	S	S	S	S	S	S	S	S	S	S
Hydraulic and travel proportional levers	S	S	S	S	S	S	S	S	S	S	S	S
Integrated diagnostic aid	S	S	S	S	S	S	S	S	S	S	S	S
Engine mounted on swiveling base					S	S	S	S	S	S	S	S
Telescopic jib									S			
Jib	S	S	S	S	S	S	S	S				
Protective cover for instruments panel	S	S	S	S	S	S	S	S	S			
Removable control box										S	S	S
Tool box in basket	S	S	S	S	S	S	S	S	S			
Travel possible at maximum height	S	S	S	S	S	S	S	S	S	S	S	S
X/Y movements (horizontal, vertical)								S	S			
BASKET												
Basket pre-fitted for 220V	0	S	S	S	S	S	S	S	S	S	S	S
230V plug with differential circuit-breaker	0	0	0	0	0	0	0	0	0	0	0	0
Pre-fitted for air	0	0	0	0	0	0	0	0	0	0	0	0
Non-slip flooring in basket	S	S	S	S	S	S	S	S	S	S	S	S
Basket length 2,100 mm		0		0	S	S						
Basket length 1,800 mm		S		S			0	0	0			
Basket length 1,500 mm	S											
Basket length 2,300 mm			S				S	S	S			
Basket with mesh floor	S	S	S	S	S	S	S	S	S			
Predisposition of water	0	0	0	0	0	0	0	0	0			
Work light in basket	0	0	0	0	0	0	0	0	0	0	0	0

	MAN'GO 12	160 ATJ	160 ATJ +	180 ATJ	200 ATJ	220 TJ	220 TJ+	260 TJ	280 TJ	100 SC	120 SC	140 SC
SAFETY												
Audible alarm and warning light (for slopes, overloading, and lowering)	S	S	S	S	S	S	S	S	S	S	S	S
Battery isolator switch	0	0	0	0	0	0	0	0	0			
Warning beep for all movements	0	0	0	0	0	0	0	0	0			
Beep when lowering										S	S	S
Beep when moving	0	0	0	0	0	0	0	0	0			
Coded anti-starting system	0	0	0	0	0	0	0	0	0			
Protective cover for basic screen	0	0		0	0	0	0	0	0			
Emergency stop button in platform and on frame	S	S	S	S	S	S	S	S	S	S	S	S
Fixed anti-shearing protection										S	S	S
Folding guard rails for passing through doors										S	S	S
Audible alarm system inside basket	S	S	S	S	S	S	S	S	S	S	S	S
Fuel tank lock	0	0	0	0	0	0	0	0	0			
Turret hood locks	0	0	0	0	0	0	0	0	0			
Slope release feature	S	S	S	S	S	S	S	S	S			
Descent alarm										S	S	S
Backup manual pump	S									S	S	S
Backup electrical pump		S	S	S	S	S	S	S	S			
Operator presence pedal	S	S	S	S	S	S	S	S	S			
Basket access gate										S	S	S
Revolving light	S	S	S	S	S	S	S	S	S	S X2	S X2	S X2
Safety harness	0	0	0	0	0	0	0	0	0	0	0	0
SMS: Safe Man System	0	0	0	0	0	0	0	0	0			
Folding position remote control						0	S	S	S			
Stabilizers with automatic leveling										S	S	S
SPECIFIC												
CAN Bus technology	S	S	S	S	S	S	S	S	S	S	S	S
Special paint	0	0	0	0	0	0	0	0	0			
Lashing rings	S	S	S	S	S	S	S	S	S	S	S	S
Biodegradable oil	0	0	0	0	0	0	0	0	0	0	0	0
Catalytic purifier	0	0	0	0	0	0	0	0	0			
Incremental management of engine speed	S	S	S	S	S	S	S	S	S			
Non-marking tyres	0	0	0	0	0	0	0	0	0	0	0	0
Oil for extreme low temperatures	0	0	0	0	0	0	0	0	0	0	0	0
Easy Manager	0	0	0	0	0	0	0	0	0			

SAFE **MAN** SYSTEM



Enhanced safety SMS: Safe Man System

The system protects operators by minimizing the risks of crushing.

The SMS does not impinge on basket space and does not interfere with the operator's view of the control panel.

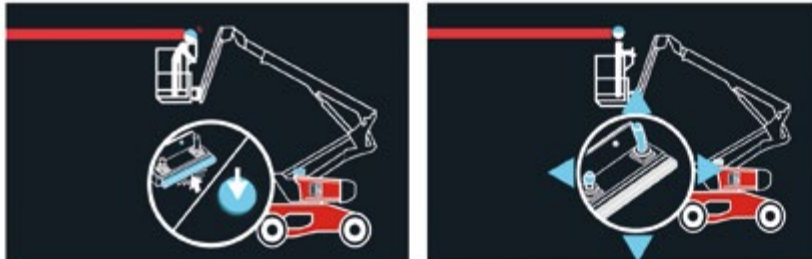

Example 1 The operator is able to escape

- Pressure sensitive bar is pressed
- All movements are stopped and alarms are activated
- Reset button to regain basket controls



Example 2 The operator is unable to escape

- Pressure sensitive bar is pressed
- All movements are stopped and alarms are activated
- A second operator can take control using controls on the ground.



Road-rail

Our platforms provide you with completely safe assistance with the maintenance of your railway lines. Tailored to the working conditions of the railways, they simplify your work on a daily basis by improving your response time.



Military / Aeronautics

Our platforms can perfectly match the specific requirements of both military and civil aviation, improving response time and ensuring operational security.



Mines / refineries

Mining operations require specific equipment, and we offer a range of solutions in the field of personnel lifting, to adapt our products to your requirements.







Manitou is here to help

So that you can benefit from an operational platform all year long, Manitou offers a wide range of products and services that are suited to all your needs.



Expertise and service **on a daily basis**

Your Manitou dealer guarantees a complete range of services at all stages of your machine's life. The dealer will support you and adapt to your needs in order to provide the best solution to meet your requirements.

1,400 dealers at your service

The Manitou network operates in more than 120 countries. In total, there are more than 2,000 expert technicians, specially trained in Manitou technology, who are at your service to assist with everything from purchasing to after-sales.



- **Dealership network**
 A network of experts at your service, whatever your activity (agriculture, construction, industry).
- **Maintenance contracts**
 3 levels of contracts: Initial, Advanced, and Excellence, which are tailored to your needs. Entrust the maintenance of your equipment to your dealer.
- **Financing**
 Lease or buy? Manitou Finance helps you choose the most suitable financing solution for your activity. Why look elsewhere?
- **Warranty extension**
 With Maniplus, you can extend the cover of your Manitou for up to 5 years. Use your equipment with peace of mind.
- **Fleet management**
 Easy Manager is a simple and flexible tool for managing, optimizing and securing the operational monitoring of your machines.
- **Second-hand**
 In the market for second-hand equipment? The Manitou network is here to help. Just visit manitou.used.com, our dedicated reference site for second-hand Manitou machines.
- **Original spare parts**
 With more than 70,000 products available, your Manitou agent provides expertise and service on a daily basis!

The REDUCE Program

The handling sector does not yet have a standardized cycle for measuring the fuel consumption of machines. However, the Manitou Group has established an internal protocol, which is accessible to everyone and shows Manitou's own consumption measurements

(l/h) and CO2 emissions (kg/h). In order to make procedures more reliable, this data is controlled and approved by an independent organization, the UTAC*, which specializes in the approval of vehicles and equipment.

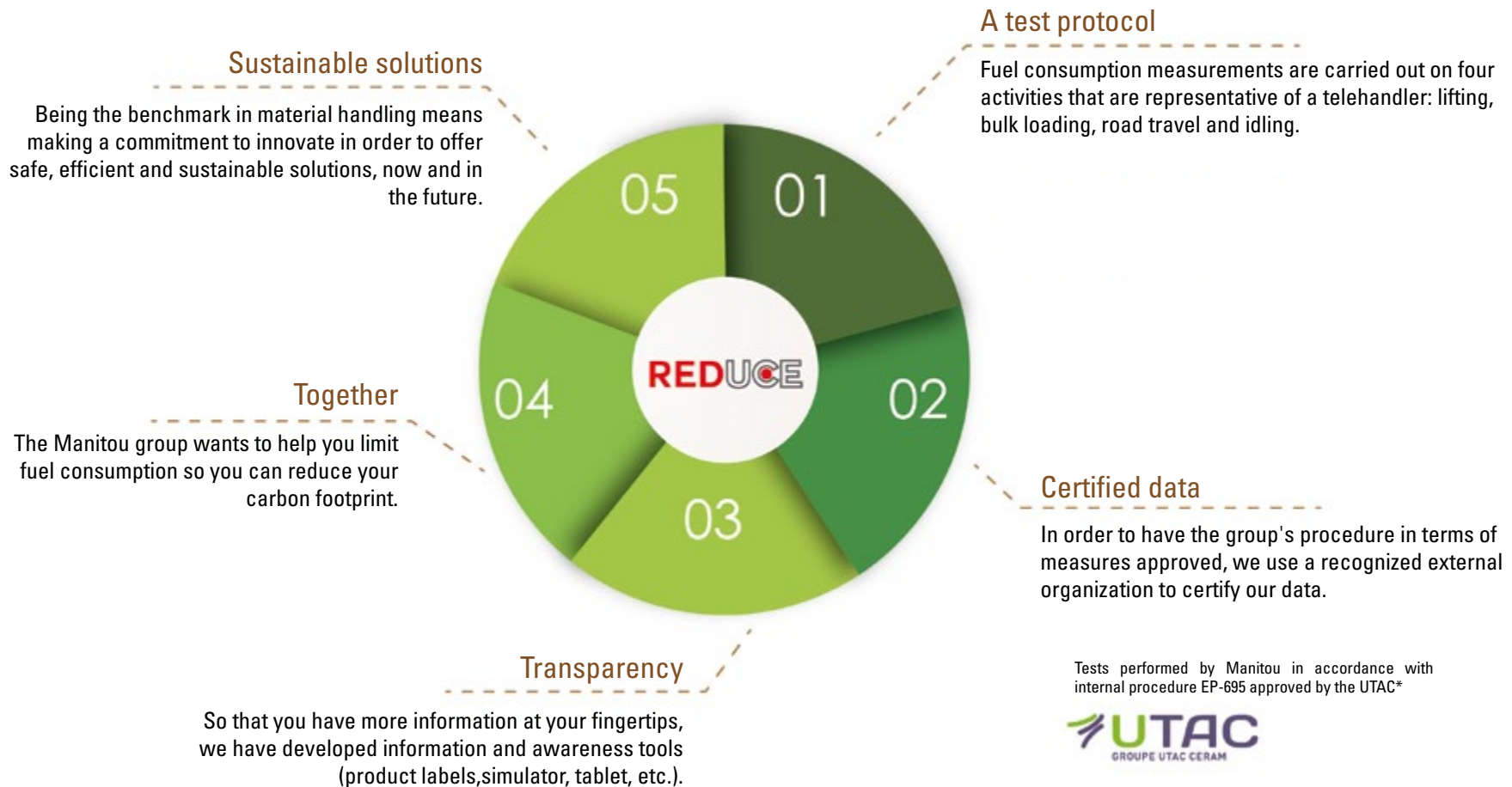

Here to assist you

The Manitou Group wants to help you reduce your fuel consumption and the carbon footprint of your machines using some simple tips. You can find all our tips at reduce.manitou.com.



Choose a machine with a suitable height for your needs.



Opt for engines fitted with automatic handling of engine speeds.



Adapt the type of tyre to your environment.



Observe the maintenance intervals.



Study the manufacturers' maintenance contracts.



Preferably buy through a manufacturer-approved dealer.



Choose original manufacturer's parts.



Lubricate regularly.



Fuel quality is important.



Regularly clean the radiator, the air filter, etc.

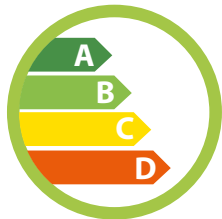

Ask about the fuel consumption and emissions of the machines.

Your dealer:



Registered office
B.P. 249 - 430 rue de l'Aubinière - 44158 Ancenis Cedex - France
Tel.: 0033 (0)2 40 09 10 11 - Fax: 00 33 (0)2 40 09 10 97

