



Electric platforms  
**RANGE**

# Handling your world

Founded over 60 years ago by the Braud family, Manitou Group now operates worldwide. A world-leader in all-terrain material handling, the Group designs, produces, distributes and services equipment intended for construction, agriculture and industries.

The Group's product ranges include: telescopic loaders including rotary and heavyweight all-terrain telescopic forklift-trucks, semi industrial and industrial all-terrain masted forklifts, compact loaders (skid-steers) on wheels or tracks, aerial work-platforms for personnel, truck-mounted forklifts, warehousing equipment and attachments.

Thanks to its high-profile brands, Manitou, Gehl and Mustang, and its network of 1,400 dealers throughout the world, the group provides the best solutions, creating most value for its customers.

With its head office in France, the group had a revenue of €1.332 billion in 2016 in 140 countries and employs 3,700 staff who are resolutely focused on customer satisfaction.



1958

First Manitou forklift truck created based on an idea from Marcel Braud.

1972

Group's global expansion began.

Sales & marketing partnership agreement signed with Toyota for the exclusive distribution of Toyota industrial forklifts in France.

1981

Manitou's first telehandler launched.

1984

The company went public.

1993

First MRT rotating telescopic forklifts were launched.

1995

Aerial workplatforms launched.

1996

Manitou was ISO-9001-certified for the first time.

1998

Marcel Braud appointed Chairman of the Supervisory Board..

2007

Manitou inaugurated a 22,000 m<sup>2</sup> international logistics center.

**3 brands**  
distributed by  
1.500 dealers  
in 140 countries

**MANITOU** | **GEHL** | **MUSTANG**

- 21 subsidiaries
- 11 production facilities
- 3.700 employees worldwide
- 65% of the share capital held by the founding families
- 78% of revenue comes from foreign markets
- Revenue of 1.332 billion euros in 2016

2008

The American Gehl Company was acquired.

2009

Governance changed and the company went back to having a Board of directors.

2010

Gehl and Mustang articulated loaders launched.

2012

Crossover agreement signed with the company Yanmar for the manufacturing and distribution of compact excavators.

2013

Partnership with Yanmar made stronger with Yanmar taking a 6,26%-stake in the Group's capital.

2014

January: Michel Denis appointed as President and CEO.  
April: new roadmap hinged in the three divisions, including one for service.

2015

Celebration of the 500,000th machine sold in the world.



2016

Launch of the new MLT range, NewAg.

*NEWAG*

2017

Inauguration of the new entity Manitou Equipment India, specialised in compact loaders and backhoes.





## Electric platforms, experience the difference!

Discover our wide range of self-propelled electric vertical, articulated and scissor lifts. Whether you are a rental company or final user, these platforms will fully meet the specific needs of your activity.



# CONTENTS

Electric  
Platforms

<b>VJR - Vertical Platforms</b>	<b>6</b>
<hr/>	
<b>AETJ - Articulated platforms</b>	<b>10</b>
<hr/>	
<b>AETJ Bi-Energy - Articulated platforms</b>	<b>16</b>
<hr/>	
<b>SEC/SE - Scissor lift platforms</b>	<b>18</b>
<hr/>	
<b>Technical specifications</b>	<b>22</b>
<hr/>	
<b>Standard and optional equipment</b>	<b>32</b>
<hr/>	
<b>Special requests</b>	<b>34</b>
<hr/>	
<b>Manitou services</b>	<b>36</b>



### Basket

Designed to accommodate two operators for a maximum load of 200 kg, our baskets are perfectly adapted to industrial requirements. They also come standard with a mesh floor and double guardrails for added safety.



350°

### Telescopic jib

Models 80 and 100 VJR boast a working outreach of up to 3.25 m. The jib has a tilting angle of 140° for easier load placement in the work area.

### Turret

Thanks to its industry-leading 355° turret rotation, this machine offers greater flexibility of use for the operator. This feature significantly increases the machine's work envelope.

### Mast

All our models feature a mast equipped with telescopic boom sections. Most lifting elements are located inside the mast for maximum protection. This technology also ensures comfort and greater stability for operators.

### Driveability

Electric travelling drive motors ensure smooth driving to accurately operate the machine in tight areas. Non-marking tyres with edges are especially suited for industrial applications.

Max. outreach  
**3.25 m**

**10 m**  
Max. working height

Basket capacity  
**200 kg**  
2 operators



## VJR RANGE

**Compactness and maneuverability** for superior accuracy



## **Compactness and maneuverability**

Thanks to their compact structure (measuring less than 1 m in width and 2 m in height), VJRs can easily pass through most industrial doors.

In addition, accurate and smooth controls allow easy operation even in tight or confined spaces.

## **Battery**

VJRs are equipped in standard with a 24v / 250Ah battery, offering enough autonomy for a whole day of work and ensuring many years of service life.

Central topping-up is also available to reduce the time used to water batteries.

A gel battery is also available for agri-food applications.

The battery charger is integrated into the machine for higher flexibility in loading areas.



## Safety

The design of our vertical mast booms ensures great stability thanks to its center of gravity, located in the lower area of the chassis.

The telescopic mast technology delivers a compact structure, which in turn increases visibility of the machine and the work environment during operations.

All VJR models have the following features:

- excellent stability, thanks to a lower center of gravity and the telescopic boom sections developed for Manitou machines;
- improved working comfort of man baskets;
- simple and intuitive controls for a quick start;
- load and tilt sensors;
- stability supports integrated into the chassis; and
- SMS technology (Safe Man System, as an option).







**VJR**

Exterior and interior finish  
works, industrial  
applications, advertising  
displays, agricultural  
applications...

## **Simplified maintenance**

Over the last years, Manitou group has been working to reduce the total cost of ownership and to increase the availability of our most important machines.

Manitou's telescopic mast system stands for quality, reliability, robustness and easy maintenance (no chains, protected lift cylinders), as confirmed by our clients.

The operator can easily access the battery and hydraulic components by unlocking the latches of the turret cover. No special tool is required.

Machine components also requires less maintenance, such as electric motors or final drives, which are lubricated for life.



## Basket

Designed to accommodate two operators for a maximum load of 200 kg, our baskets are perfectly adapted to industrial requirements. They also come as standard with a mesh floor and double guardrails for added safety.



## Turret

A hydraulic motor is directly linked to the turret rotation speed, ensuring greater robustness and reliability. The turret can rotate up to 355°. To safely transport the machine, the turret can be locked by means of a latch.

## Transmission

AETJs are equipped with two front-wheel steering and two rear-wheel drive, operated by two 4500-watt electric motors, combining power and flexibility of use.

## Structure

Our structures have always been recognised for their design and long-term durability. Whichever product you choose, the articulation heights and working outreach have set a benchmark in their category. For increased safety, each lift cylinder is equipped with a security valve.

## Chassis

Each product within the AETJ range features a mechanically welded chassis with two battery blocks on each side for better weight distribution. The steering cylinders are well-protected and integrated into the chassis.

Max. outreach of  
**9.43m**

**17 m**  
Working height  
max.

**3 models**  
**3 chassis**

**AETJ RANGE**  
**Overcome any obstacle**





## Productivity and performance

Reach the furthest areas with ease, regardless of the model.

The 120 AETJ-C features the best outreach/compactness ratio in its category.

The 170 AETJ-L stands out for its outstanding outreach and up and over height, without the need to move the machine.

## 3D option

The 120 AETJ-C and 150 AETJ-C feature a 3D jib, meaning that you can easily negotiate around obstacles such as piping, beams or pillars.

This lateral rotation system delivers greater access in any area, increasing productivity.



## Comfort

Thanks to a set of ergonomic and intuitive controls, you can easily operate your machine.

You also benefit from smooth hydraulic movements to meet your ideal work position.







## Safety

You can work in total safety. Our AETJs feature the following components:

- Basket with mesh floor for higher visibility.
- Basket with double guardrails and SMS\* (option) to better protect the operator.
- Load and tilt sensors to reduce risks.
- Safety valves on cylinders to ensure that position is maintained in the event of a hose rupture.
- Negative braking system.
- Anti-rollover bar with automatic operation (120AETJC only)
- Emergency pump.

\*Safe Man System (see page 34)

## Traction battery

Since its inception, Manitou has proposed traction batteries for its electric platforms.

A decision oriented to customer satisfaction:

- higher level of autonomy;
  - longer cycle life;
- longer service life compared to the market's standard technology; and
- higher profits, reflected in the total cost of ownership (TCO).



## Autonomy

Cycle of a EURL battery:

A test is carried out on flat level ground, applying the rated load of the basket (200 kg), at an external temperature of 18°.

- Forwards and backwards motion over 30.5 m
- Full lifting and lowering
- 1/4 turret left (90°) and right rotation (return to 0 position )
- 1/4 basket left and right rotation (return to upright position of basket)

The ignition key is not switched off between the cycles.

A cycle restarts every 20 minutes.

Maximum number of cycles with standard battery

- 120 AETJ = 60
- 150 AETJ = 48
- 170 AETJ = 45
- 100 VJR = 29

## Chargers

All Manitou electric platforms come standard with an integrated, waterproof, multi-voltage (110/230v) and well-protected charger.

A charging time of between 9 and 10 hours is required to fully recharge the battery.

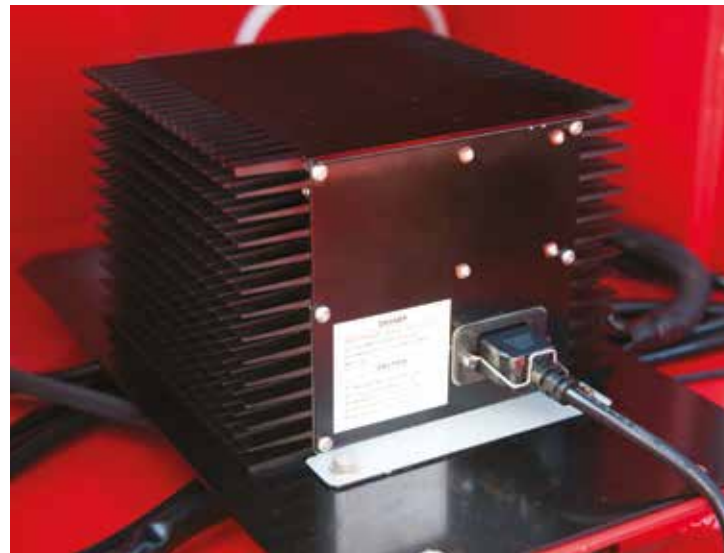



## **AETJ** Range

Building maintenance,  
industrial applications,  
advertising displays,  
construction, aeronautics,  
events...

### **Maintenance made easier**

Thanks to its integrated and intelligent Can Bus technology, you can obtain a rapid diagnosis of your machine.

The operator can easily access main components, reducing turnaround times.

We have properly routed hose assemblies to prevent them from interfering with other components.

Electric components are also well-protected from dust and humidity thanks to a double casing.

To reduce oil change costs, we have optimised the quantity of hydraulic oil.





## Bi-Energy Models

The Bi-Energy system is an innovative feature that combines the autonomy of a diesel engine and the smooth and silent performance of an electric motor.

Outreach up to  
**9.43 m**

Basket capacity  
**230 kg**  
2 operators

**2 models**  
1 chassis







## How does it work?

AETJ Bi-Energy models are always powered by electrical energy. In certain applications (outdoor works), a diesel engine can be used. The engine energy is transmitted to a generator, which sends electrical power to the battery. Therefore, batteries are recharged quickly during machine operation (approximately 4 hours).

## Main advantages:

- Specially designed for intensive applications.
- Higher level of autonomy of machine.
- Smoother shifting of working environments (indoors and outdoors).
- Semi-industrial non-marking foam filled tyres.
- Improved ground clearance.
- Work in silent mode (downtown, night work...).

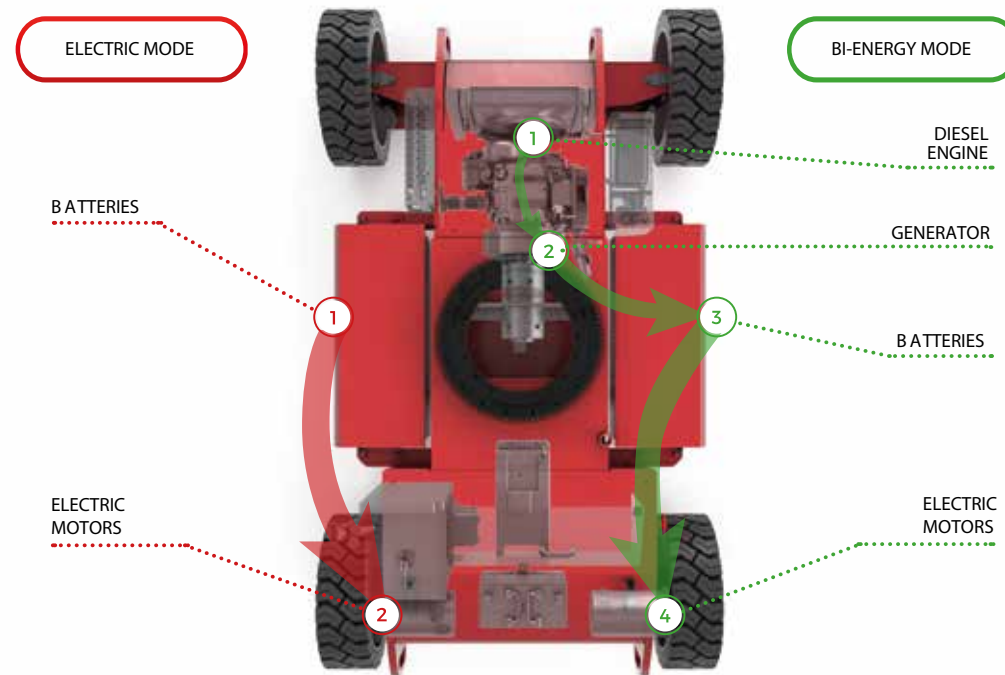

**Basket**  
All baskets come with a non-slip floor and a gate entrance, which includes a step for safer access.

**Extension deck**  
For an even larger workspace, a simple pedal can easily extend the basket floor by 91 cm. The maximum authorised weight for the floor extension deck amounts to 113 kg.

**Structure**  
All SE/SEC platforms come with double scissors with reinforced arms for increased robustness and safety. The large axes are nitrided and do not need lubrication.



**3 models**  
**2 chassis**

**12 m**  
Max. working height

Max. basket capacity  
**318 kg**  
2 operators

### Chassis

Each mode is equipped with a mechanically welded chassis. A roll-over protection system is automatically activated during lifting.

### Wheels

The non-marking, rubber tyres with grooves are perfectly adapted to indoors activities. In addition, thanks to a 90° steering angle, the inner turning radius is zero, ensuring greater maneuverability in confined spaces. This range features also front wheel dynamic braking and rear wheel multi-disc braking, which reduce braking distances.

**SEC-SE RANGE**  
**Choose simplicity**





## Operator comfort

The extension deck, accurately guided by rollers, increases the work surface, which translates into more space for operators or additional tools.

The control box may be removed and placed in any point along the upper guardrail of the basket, as required by the operator. The operator can also control the machine from outside the basket.



Thanks to their narrow chassis, the 78 and 100 SEC models can easily pass through a standard door. The folding guardrails can also reduce the overall height of the machine (less than 2m).



## Safety

All SE/SEC models include safety devices for the operators to work with peace of mind.

- Double scissor lifts are integrated into the chassis axle for increased stability.
- Anti-rollover bars with automatic operation.
- Anti-shearing protection system (automatic blocking before fully lowering the platform).
- Non-slip floor



## **SEC-SE** RANGE

Finish work;  
industrial cleaning;  
inventory;  
events

### **Maintenance**

Excellent accessibility to major components facilitate daily inspections and maintenance, thanks to two lateral doors (tank / engine / filtre).

The machine axes undergo a nitriding process and do not need lubrication. In the event of loss of power or if the platform is blocked, you can use a handle to easily lower the platform using gravity.

You can also use a dice tool to release brakes without the need of any other special tool.

For even higher response, control posts are equipped with a screen and diagnostic system — an ideal solution to quickly detect any issue and reduce turnaround time.







MANITOU

1270 AETJ L

1270 AETJ C 80

MANITOU





## Electric platforms 11 models to discover

Discover our wide range of electric platforms. On even ground or not, whether you are a renting or using it, Manitou platforms are the result of many years honing our development efforts around customers' requirements.

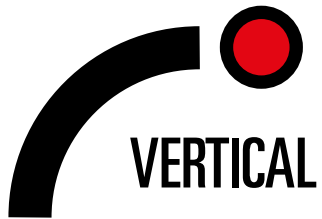

**80 VJR**

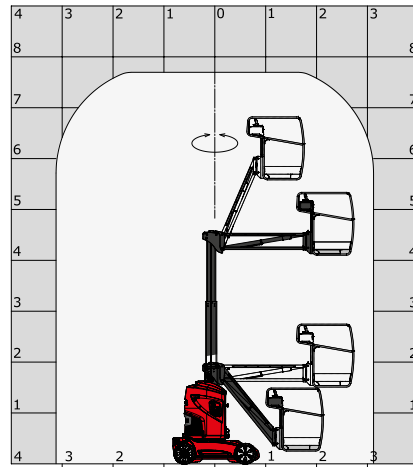

**100 VJR**

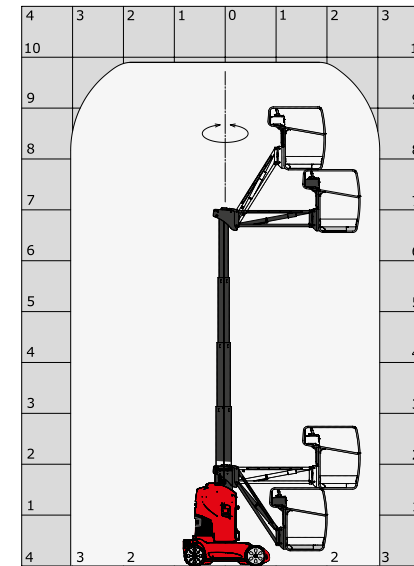

Basket capacity	kg	200
Working height	m	7.65
Platform height	m	5.65
Working outreach	m	3.24
Up and over height	m	4.24
Platform dimensions (LxWxH)	m	2.95 x 0.99 x 1.99
Transport dimensions (LxWxH)	m	2.95 x 0.99 x 1.99
Basket dimensions (LxW)	m	1.11 x 0.93
Battery	Ah/V	250 / 24
Tyres		Non marking with edges
Unladen weight	kg	2250

kg	200
m	9.85
m	7.85
m	3.15
m	6.67
m	2.8 x 0.99 x 1.99
m	2.8 x 0.99 x 1.99
m	1.11 x 0.93
kw	250 / 24
	Non marking with edges
kg	2650



Number of persons



Turret rotation



Continuous turret rotation



Steering wheels & drive wheels



Gradeability





## 90 VAIR

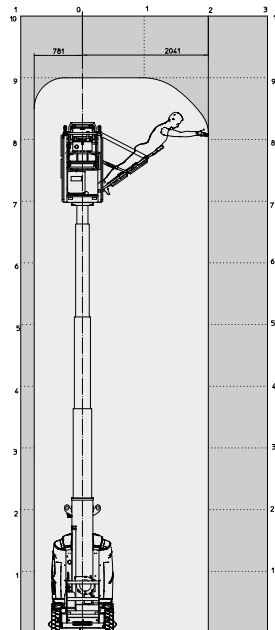

kg	230
m	9
m	7
m	2.04
m	-
m	2.31 x 1.1 x 2.31
m	2.31 x 1.1 x 2.31
m	0.95 x 0.68
Ah/V	250 / 24
	Non marking with edges
kg	2710



# ARTICULATED



**120 AETJ-C**



Basket capacity	kg	200
Working height	m	11.95
Platform height	m	9.95
Working outreach	m	7
Up and over height	m	4.77
Platform dimensions (LxWxH)	m	5.48 x 1.2 x 1.99
Transport dimensions (LxWxH)	m	3.74 x 1.2 x 2.16
Basket dimensions (LxW)	m	1.2 x 0.92
Battery	Ah/V	240 / 48
Tyres		Non marking with edges
Unladen weight	kg	6660

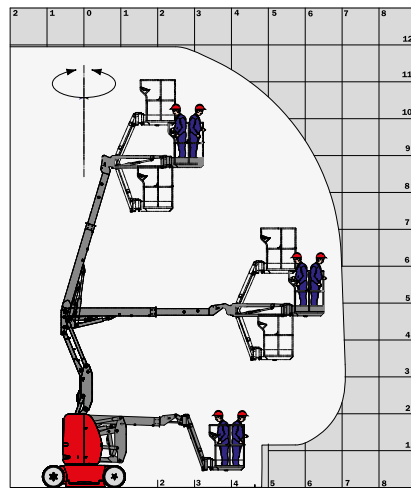

**150 AETJ-C**



kg	200
m	15
m	13
m	7.6
m	7
m	6.05 x 1.5 x 1.97
m	4.4 x 1.5 x 2.08
m	1.2 x 0.92
kw	240 / 48
	Non marking with edges
kg	6700

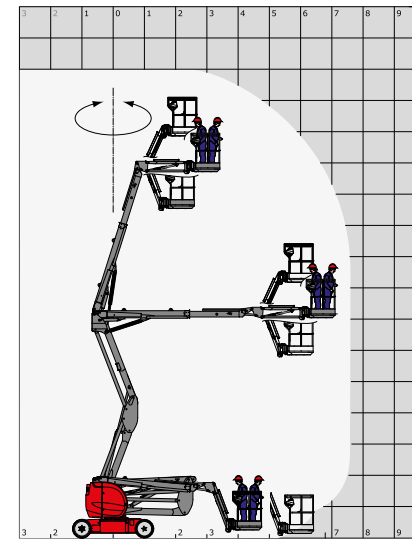

Number of persons



Turret rotation



Continuous turret rotation



Steering wheels & drive wheels



Gradeability





**170 AETJ-L**



kg	200
m	16.9
m	14.9
m	9.43m
m	7.15
m	6.84 x 1.75 x 1.97
m	5.12 x 1.75 x 2.04
m	1.2 x 0.92
kw	240 / 48
	Non marking with edges
kg	6910

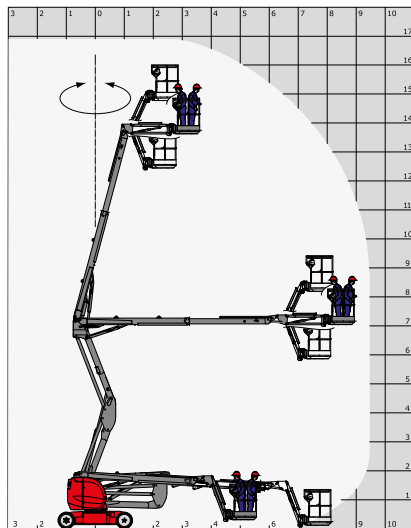

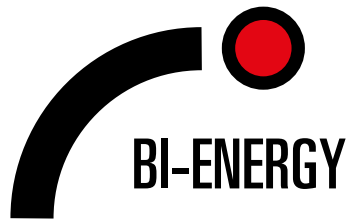

### 150 AETJ-L BI-ENERGY



Basket capacity	kg	230
Working height	m	15.4
Platform height	m	13.4
Working outreach	m	7.81
Up and over height	m	7.27
Platform dimensions (LxWxH)	m	6.11 x 1.9 x 2.1
Transport dimensions (LxWxH)	m	4.55 x 1.9 x 2.13
Basket dimensions (LxW)	m	1.2 x 0.92
Battery	Ah/V	300 / 48
Tyres		Non marking foam filled
Unladen weight	kg	6435

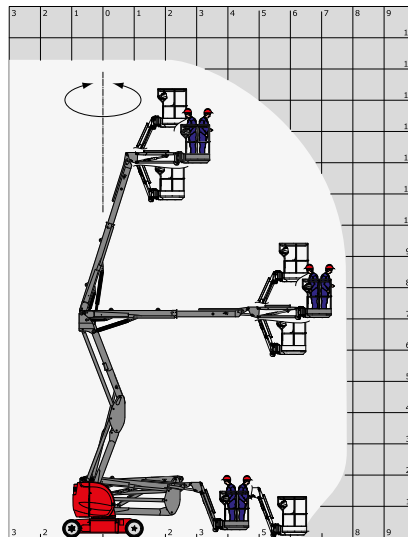

### 170 AETJ-L BI-ENERGY



kg	230
m	17
m	15
m	9.43
m	7.27
m	6.97 x 1.9 x 2.1
m	5.25 x 1.9 x 2.13
m	1.2 x 0.92
kw	300 / 48
	Non marking foam filled
kg	7435

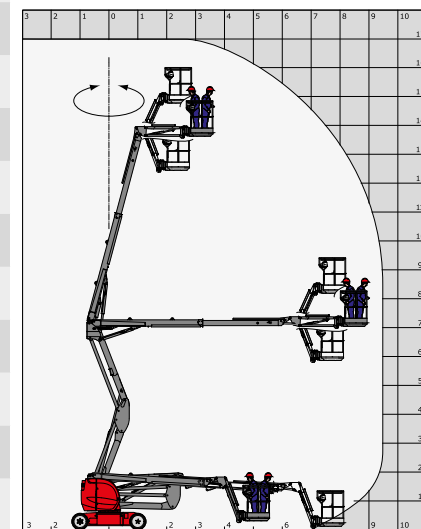

Number of persons



Turret rotation



Continuous turret rotation



Steering wheels & drive wheels



Gradeability



**VJR**



**AETJ**



**TRANSPORT**  
Version

**SEC**





# SCISSORS



**78 SEC**



Basket capacity	kg	227
Working height	m	7.79
Platform height	m	5.79
Machine dimensions (LxWxH)	m	1.83 x 0.81 x 2.1
Basket w/o extension deck (LxWxH)	m	1.83 x 0.81 x 1.75
Extension deck length	m	0.91
Ground clearance.	m	0.1
Drive speed	km/h	4
Battery	Ah/V	225 / 4x6
Tyres		Non marking with edges
Unladen weight	kg	1503

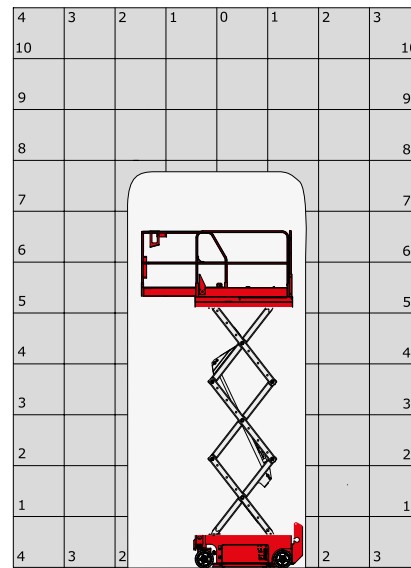

**100 SEC**



kg	227
m	9.92
m	7.92
m	2.26 x 0.81 x 2.26
m	2.26 x 0.81 x 1.91
m	0.91
m	0.1
km/h	3.5
kw	225 / 4x6
	Non marking with edges
kg	1959

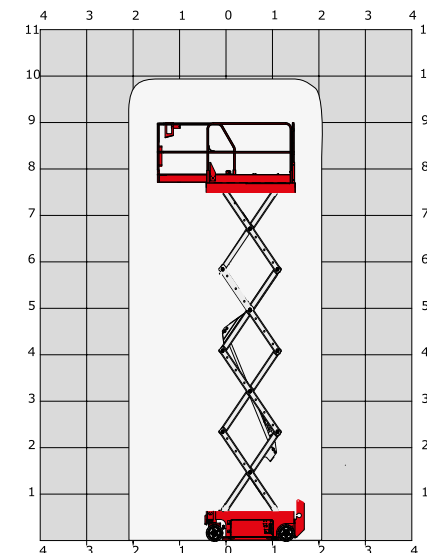

Number of persons



Turret rotation



Continuous turret rotation



Steering wheels & drive wheels



Gradeability





**120 SE**



kg	318
m	11.75
m	9.75
m	2.44 x 1.17 x 2.39
m	2.44 x 1.17 x 1.8
m	0.91
m	0.1
m	3.5
kw	225 / 4x6
	Non marking with edges
kg	2812

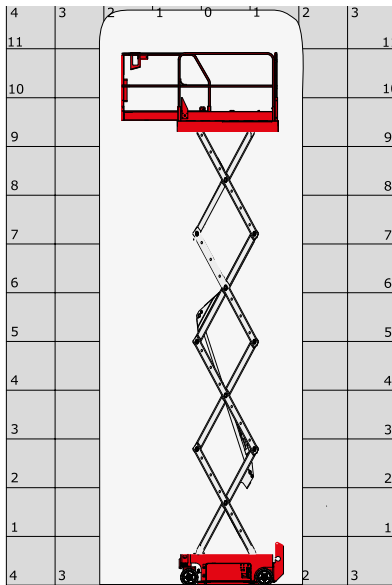

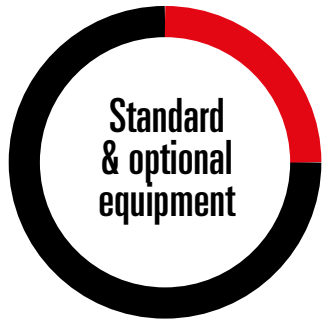

	80 VJR	100 VJR	90 V AIR	120 AETJ-C	150 AETJ-C	170 AETJ-L	150 AETJ-L BI-ENERGY	170 AETJ-L BI-ENERGY	78 SEC	100 SEC	120 SE
<b>COMFORT AND PRODUCTIVITY</b>											
Hour meter	S	S	S	S	S	S	S	S	S	S	S
Hydraulic and drive proportional controls	S	S	S	S	S	S	S	S	S	S	S
Telescopic jib	S	S	-	S	S	S	S	S	-	-	-
Protective cover for instrument panel of basket	-	-	S	0	0	0	S	S	-	-	-
Removable control box	-	-	-	-	-	-	-	-	S	S	S
Tool box in basket	S	S	S	S	S	S	S	S	-	-	-
Driving possible at maximum height	S	S	S	S	S	S	S	S	S	S	S
3D	-	-	-	0	0	-	-	-	-	-	-
<b>BASKET</b>											
Pre-fitted for 230V	0	0	-	S	S	S	S	S	S	S	S
230V plug with differential circuit-breaker	0	0	-	0	0	0	0	0	-	-	-
Pre-fitted for air	0	0	-	0	0	0	0	0	0	0	0
Non-slip flooring in basket	S	S	S	S	S	S	S	S	S	S	S
Basket with mesh floor	S	S	S	S	S	S	S	S	-	-	-
Predisposition of water	0	0	-	0	0	0	0	0	-	-	-
Basket worklights	0	0	S	0	0	0	0	0	0	0	0
1200 mm basket	-	-	-	S	S	S	S	S	-	-	-
Basket extension deck	-	-	-	-	-	-	-	-	S	S	S
<b>BATTERY</b>											
Battery charge indicator	S	S	S	S	S	S	S	S	S	S	S
Integrated multi-voltage charger	S	S	S	S	S	S	S	S	S	S	S
Integrated multi-voltage charger — gel battery	0	0	0	0	0	0	-	-	-	-	-
24V 250Ah traction battery	S	S	S	-	-	-	-	-	-	-	-
24V 250Ah gel traction battery	0	0	0	-	-	-	-	-	-	-	-
48V 240Ah traction battery	-	-	-	S	S	S	-	-	-	-	-
48V 300Ah traction battery	-	-	-	0	0	0	S	S	-	-	-
48V 360Ah traction battery	-	-	-	-	0	0	-	-	-	-	-
48V 300Ah gel traction battery	-	-	-	0	-	-	-	-	-	-	-
48V 275Ah gel traction battery	-	-	-	-	0	0	-	-	-	-	-
Central topping-up	0	0	S	0	0	0	0	0	-	-	-
Semi-traction monobloc battery on pivot	-	-	-	-	-	-	-	-	S	S	S



# ELECTRIC PLATFORM RANGE

	80 VJR	100 VJR	90 V'AIR	120 AETJ-C	150 AETJ-C	170 AETJ-L	150 AETJ-L BI-ENERGY	170 AETJ-L BI-ENERGY	78 SEC	100 SEC	120 SE
<b>SAFETY</b>											
Audible alarm and warning light (for slopes, overloading, and lowering)	S	S	S	S	S	S	S	S	S	S	S
Battery isolator switch	-	-	-	S	S	S	S	S	-	-	-
All motion warning beeps	0	0	-	0	0	0	0	0	0	0	0
Beeps when lowering	S	S	S	S	S	S	S	S	S	S	S
Beeps when driving	0	0	-	0	0	0	0	0	-	-	-
Emergency stop button in platform and on frame	S	S	S	S	S	S	S	S	S	S	S
Fixed anti-shearing protection	-	-	-	-	-	-	-	-	S	S	S
Folding guardrails to pass through doors	-	-	-	-	-	-	-	-	S	S	S
Audible alarm system inside basket	S	S	S	S	S	S	S	S	S	S	S
Fuel tank lock	-	-	-	-	-	-	0	0	-	-	-
Emergency manual pump	S	S	S	S	S	S	S	S	-	-	-
Basket access gate	-	-	S	-	-	-	-	-	S	S	S
Flashing lights	0	0	S	0	0	0	0	0	S	S	S
Safety harness	0	0	0	0	0	0	0	0	0	0	0
SMS: Safe Man System	0	0	-	0	0	0	-	-	-	-	-
Fixed pothole protection	S	S	S	-	-	-	-	-	-	-	-
Automatic pothole protection	-	-	-	S	-	-	-	-	S	S	S
Negative braking system on rear wheels	S	S	S	S	S	S	S	S	S	S	S
<b>SPECIFIC</b>											
Can Bus technology	S	S	S	S	S	S	S	S	S	S	S
Special paint	0	0	-	0	0	0	0	0	-	-	-
Tie down lugs	S	S	S	S	S	S	S	S	S	S	S
Lifting lugs	S	S	S	S	S	S	S	S	S	S	S
Biodegradable oil	0	0	0	0	0	0	0	0	0	0	0
Non-marking tyres	S	S	S	S	S	S	S	S	S	S	S
All terrain non-marking foam filled tyres	-	-	-	-	-	0	S	S	-	-	-
Low temperature oil	0	0	0	0	0	0	0	0	0	0	0
Easy Manager	0	0	0	0	0	0	0	0	-	-	-

Specifications may vary according to the regulations in force in the country of use or with the addition of optional equipment. Manitou is constantly researching and developing new products and reserves the right to make any changes without prior warning.



## Enhanced safety SMS: Safe Man System

SMS protects operators by minimising the risks of crushing accidents.

The system does not impinge on basket space and does not interfere with the operator's view of the control panel.

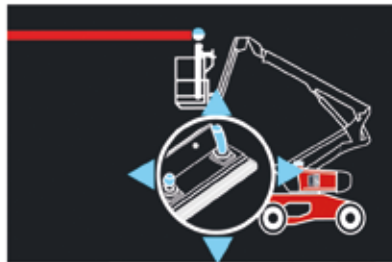

### Example 1 The operator is able to escape

- Pressure sensitive bar is pressed
- All movements are stopped and alarms are activated
- Reset button to regain basket controls



### Example 2 The operator is unable to escape

- Pressure sensitive bar is pressed
- All movements are stopped and alarms are activated
- A second operator can take control using controls on the ground





## Aeronautics

Over the past several years, we have been developing platform-based solutions adapted to aircraft maintenance. Our solutions range from classic models mounted on a machine and with specific features, to products specifically designed to aeronautics applications, like the 90V'Air.



## Customised painting

We can customise the colours of our machines to match your company colours, whether you are renting or using them.



## Military

Our platforms can perfectly meet the specific needs of both military and civil aviation, improving response time and ensuring operational security.



MANITOU







## **Manitou is here to help!**

So that you can benefit from an operational forklift all year long, Manitou offers a wide range of products and services that are suited to all your needs.



## Expertise and service on a daily basis

Your Manitou dealer can guarantee a complete range of services at all stages of your machine's life and is there to provide support and meet your needs, always looking to provide you with the best solution.



## 1 400 dealers at your service

The Manitou network is present in more than 120 countries, with over 2,000 expert technicians, specially trained in Manitou technology, who are at your service to assist with everything from purchasing to after-sales.



- **Dealer network**  
 A network of experts at your service, whatever your activity (agriculture, construction, industry).
- **Maintenance contracts**  
 3 levels of contracts which are tailored to your specific needs: Initial, Advanced, and Excellence. Leave maintenance to your Manitou dealer.
- **Financing**  
 Buy or rent? Whatever your business, simplify your investment with financing or leasing solutions using Manitou Finance.
- **Warranty extension**  
 With Maniplus, you can extend coverage on your Manitou for up to 5 years. Use your machine with full peace of mind.
- **The connected solution**  
 Easy Manager is a simple and flexible tool for managing, optimizing and securing the operational monitoring of your machines.
- **Used**  
 In the market for second-hand equipment? The Manitou network can help you. Visit your dealer or [used.manitou.com](http://used.manitou.com), our dedicated reference site for second-hand machines.
- **Genuine spare parts**  
 With more than 70,000 parts available, your Manitou dealer never fails to give you expertise and service you need!



Your dealer :



Head office

B.P. 249 - 430 rue de l'Aubinière - 44158 Ancenis Cedex - France

Tél. : 00 33 (0)2 40 09 10 11 - Fax: 00 33 (0)2 40 09 10 97

